

2" General Service Gauge

NSF Listed

Our line of general service gauges provide an affordable and versatile option for use in non-corrosive environments such as air, gas, oil, and water. This 2" gauge comes in a variety of pressure ranges and connection types to suit a wide field of applications.



Sample Product Photo

- Optional Silver Ring around Lens
- Custom Logo & Color Band on Dial
- Single, Dual, or Triple Scale Customizable
- Dial Face, Markings, & Needle Customizable
- Application Fields include Compressors, Pumps, Hydraulic & Pneumatic Systems, and Regulators

Specifications

Dimensions	2" Dial Diameter
Case	Black Painted Steel Case (Standard)
Lens	Polycarbonate or Glass
Markings & Dial	Black Markings on White Dial (Single Scale) or Black and Blue Markings on White Dial (Triple & Dual Scale)
Pressure Range	See next page table. 0 psi up to 4000 psi or, Vacuum/Compound 30" Hg up to 150 psi
Unit Scale (Dual & Triple)	Bar, kPa, ft. H2O, and others
Socket & Bourdon Tube	Brass[^] (Standard) or Lead-Free Brass

[^]Pressure gauges with Brass Components will have a Proposition 65 Warning Label for lead content.

Needle Options

- Red
- Black (Standard)
- White

Connection Options

- Center Back
- Bottom Low

Thread Options

- 1/8" NPT
- 1/4" NPT
- With Optional Restrictor

Mounting Options

- Front Flange
- Rear Flange
- U Clamp

2" General Service Gauge

Available Pressure Ranges*

Vacuum/Compound Ranges in HG [‡]	Pressure Ranges in PSI	
30"Hg - 0 psi	0 to 15 psi	0 to 400 psi
30"Hg - 15 psi	0 to 30 psi	0 to 600 psi
30"Hg - 30 psi	0 to 60 psi	0 to 1000 psi
30"Hg - 60 psi	0 to 100 psi	0 to 1500 psi
30"Hg - 150 psi	0 to 160 psi	0 to 2000 psi
	0 to 200 psi	0 to 3000 psi
*Also available in cmHG	0 to 300 psi	0 to 4000 psi

*Contact for greater ranges than shown.

‡Dual/Triple scale also available in Bar, kPa, ft. H₂O, etc.

Sample Technical Drawings

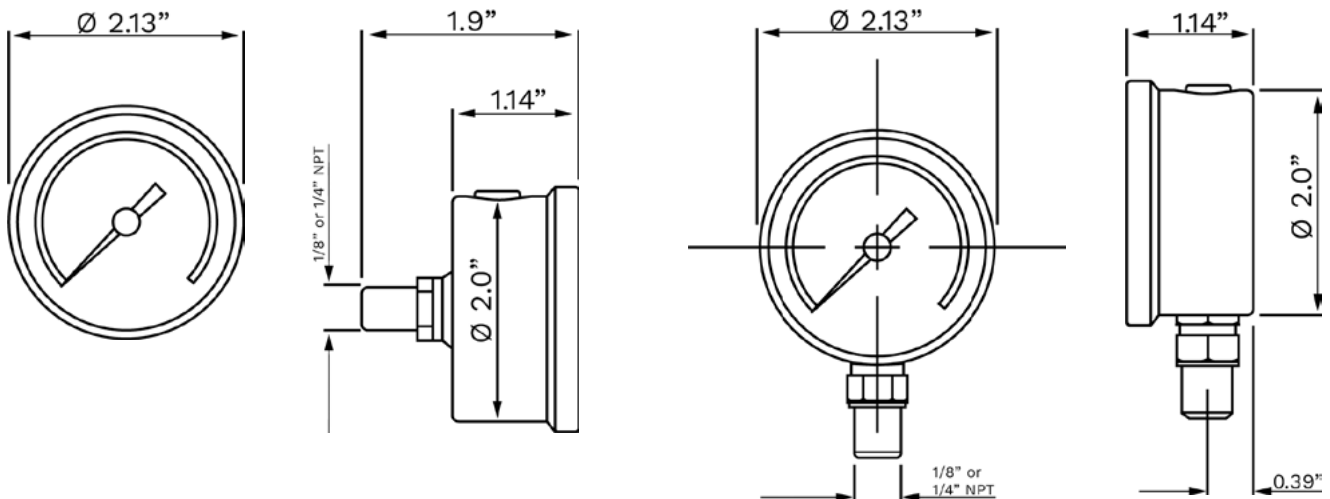

Center Back

Bottom Low